

Art.Nr. 10856501-SB

Dichtungssatz Sprühleitung | Gasket set spraying equipment | Jeu de joints pour lance | Set di guarnizioni per impugnatura

Spray-Matic 2 S, 5 S, 5 SI, 10 S, 10 SP, 20 SH

Für Spray-Matic 2 S, 5 S, 5 SI, 10 S, 10 SP, 20 SH ab 2019
 For Spray-Matic 2 S, 5 S, 5 SI, 10 S, 10 SP, 20 SH from 2019
 Pour Spray-Matic 2 S, 5 S, 5 SI, 10 S, 10 SP, 20 SH à partir de 2019
 Per Spray-Matic 2 S, 5 S, 5 SI, 10 S, 10 SP, 20 SH dal 2019

2	Flachdichtung Gasket Joint Guarnizione	24 x 16.2 x 2
6	Flachdichtung Gasket Joint Guarnizione	24 x 16.2 x 2
9	Flachdichtung Gasket Joint Guarnizione	17 x 12.7 x 2 (2x)
8	Flachdichtung Gasket Joint Guarnizione	17 x 11 x 1.5 (2x)
4	Flachdichtung Gasket Joint Guarnizione	12.2 x 7 x 3
7	Flachdichtung Gasket Joint Guarnizione	11 x 7.6 x 2
1	O-Ring O-ring Joint torique O-ring	10 x 2
10	O-Ring O-ring Joint torique O-ring	7.66 x 1.78
5	Stopfbüchspackungsring Gland packing Garniture presse-étoupe Baderna	14.7 x 5.1 x 10.5
3	Ventilstange Valve rod Tige de soupape Asta della valvola	
3	Formdichtung Shaped packing Joint d'étanchéité en form Guarnizione	11.8 x 4 x 4
3	Fassung Rim Support Montaggi	
11	Filter Filter Filtre Filtro	
Ab From À partir de Dal 2024		
12	Flachdichtung Gasket Joint Guarnizione	18.5 x 12 x 2

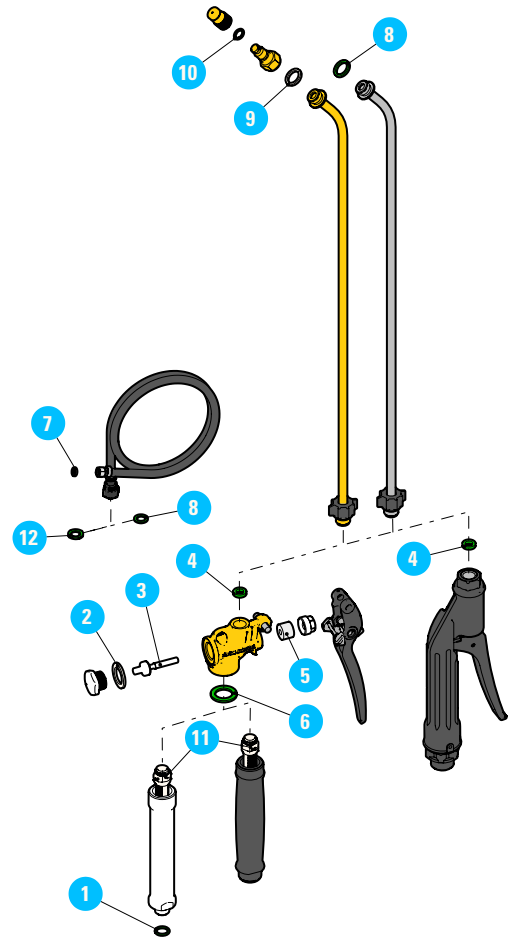

Für Spray-Matic 2 S, 5 S, 5 SI, 10 S, 20 SH bis 2018
 For Spray-Matic 2 S, 5 S, 5 SI, 10 S, 20 SH to 2018
 Pour Spray-Matic 2 S, 5 S, 5 SI, 10 S, 20 SH à 2018
 Per Spray-Matic 2 S, 5 S, 5 SI, 10 S, 20 SH a 2018

2	6	Flachdichtung Gasket Joint Guarnizione	24 x 16.2 x 2
9		Flachdichtung Gasket Joint Guarnizione	17 x 12.7 x 2 (2 x)
8		Flachdichtung Gasket Joint Guarnizione	17 x 11 x 1.5 (2 x)
4		Flachdichtung Gasket Joint Guarnizione	12.2 x 7 x 3
7		Flachdichtung Gasket Joint Guarnizione	11 x 7.6 x 2
5		Stopfbüchspackungsring Gland packing Garniture presse-étoupe Baderna	14.7 x 5.1 x 10.5
3		Ventilstange Valve rod Tige de soupape Asta della valvola	
11		Filter Filter Filtre Filtro	

i Rückseite beachten
 Note back
 Veuillez lire le verso
 Nota sul retro

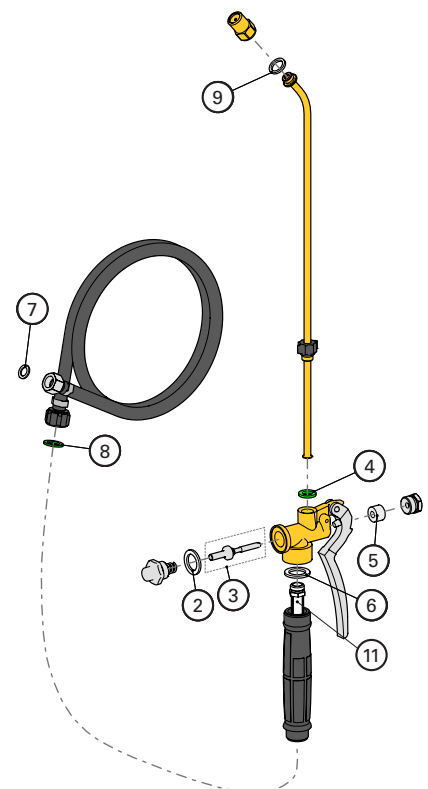

Art.Nr. 10856501-SB

Dichtungssatz Sprühleitung | Gasket set spraying equipment | Jeu de joints pour lance | Set di guarnizioni per impugnatura

Spray-Matic 2 S, 5 S, 5 SI, 10 S, 10 SP, 20 SH

Flachdichtung
Gasket
Joint
Guarnizione

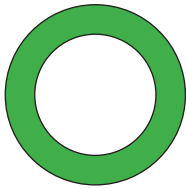

⑥ 6 24 x 16.2 x 2

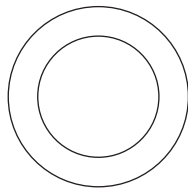

② 2 24 x 16.2 x 2

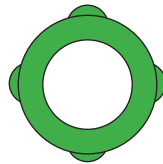

⑫ 12 18.5 x 12 x 2

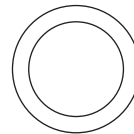

⑨ 9 17 x 12.7 x 2
(2 x)

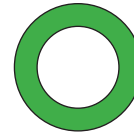

⑧ 8 17 x 11 x 1.5
(2 x)



④ 4 12.2 x 7 x 3



⑦ 7 11 x 7.6 x 2

O-Ring
O-ring
Joint torique
O-ring



① 1 10 x 2



⑩ 10 7.66 x 1.78

Stopfbüchspackungsring
Gland packing
Gorniture presse-étoupe
Guarnizione pressacavo

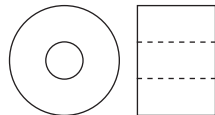

⑤ 5 14.7 x 5.1 x 10.5

Fassung
Rim
Support
Porta asta

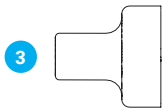

③

Formdichtung
Shaped packing
Joint d'étanchéité en form
Guarnizione

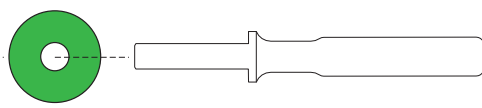

Ventilstange
Valve rod
Tige de soupape
Asta della valvola

Ventilstange
Valve rod
Tige de soupape
Asta della valvola

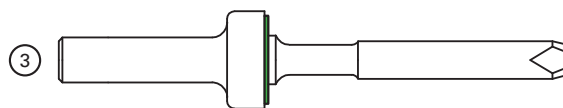

③

Filter
Filter
Filtre
Filtro

⑪ 11

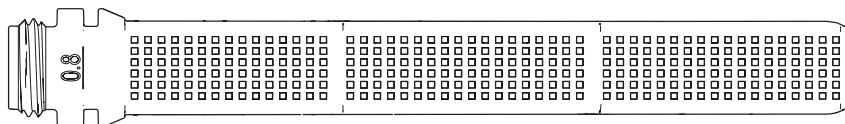

● Version ab 2019
Version from 2019
Version à partir de 2019
Versione dal 2019

○ Version bis 2018
Version to 2018
Version à 2018
Versione a 2018